

## PERFECT cable gland

50.0xx PAzzzz

Dome nut	Polyamide PA6 V-2
Sealing ring	Polychloroprene-Nitrile rubber CR/NBR
Gland body	Polyamide PA6 V-2
Connecting thread	Pg as per DIN 40430



### Properties

	<ul style="list-style-type: none"> <li>integrated anchorage</li> <li>wide sealing and clamping range</li> <li>easy-to-install</li> </ul>
Temperature range (°C)	-20°C / +100°C (dynamic) -40°C (static, short term)
Protection grade	68 5
Test standard	UL 514B
UL / CSA-File	E140310
Comment	details about tests - see annex

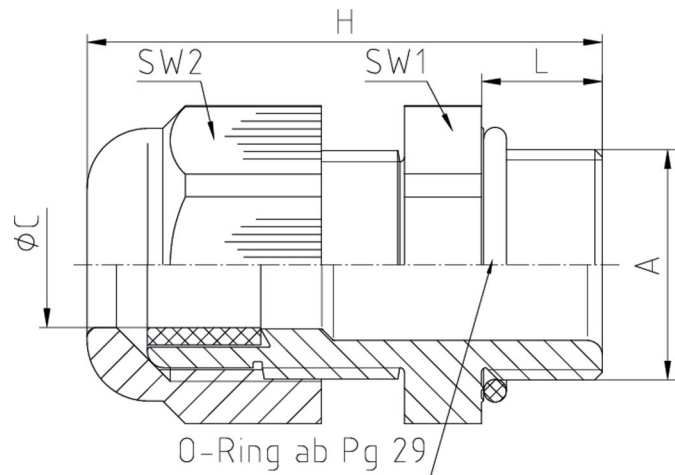

### Features



RAL 9005

### Connecting thread standard length

A	ØC	L	SW1	SW2	H		Part No.
Pg 7	3 - 6,5	8	15	15	30,5	100	50.007 PA/SW
Pg 9	4 - 8	8	19	19	34	100	50.009 PA/SW
Pg 11	5 - 10	8	22	22	37	100	50.011 PA/SW
Pg 13,5	6 - 12	9	24	24	39	100	50.013 PA/SW
Pg 16	10 - 14	10	27	27	42,5	50	50.016 PA/SW
Pg 21	13 - 18	11	33	33	47,5	50	50.021 PA/SW
Pg 29	18 - 25	11	42	42	53	25	50.029 PA/SW
Pg 36	22 - 32	13	53	53	61	10	50.036 PA/SW
Pg 42	30 - 38	13	60	60	65	5	50.042 PA/SW
Pg 48	34 - 44	14	65	65	67	5	50.048 PA/SW

### Connecting thread long

A	ØC	L	SW1	SW2	H		Part No.
Pg 7	3 - 6,5	15	15	15	37,5	100	50.007 PASW15
Pg 9	4 - 8	15	19	19	41	100	50.009 PASW15
Pg 11	5 - 10	15	22	22	44	100	50.011 PASW15
Pg 13,5	6 - 12	15	24	24	45	100	50.013 PASW15
Pg 16	10 - 14	15	27	27	47,5	50	50.016 PASW15
Pg 21	13 - 18	15	33	33	51,5	50	50.021 PASW15
Pg 29	18 - 25	15	42	42	57	25	50.029 PASW15
Pg 36	22 - 32	18	53	53	66	10	50.036 PASW18





RAL 7035

## Connecting thread standard length

A	ØC	L	SW1	SW2	H		Part No.
Pg 7	3 - 6,5	8	15	15	30,5	100	50.007 PA7035
Pg 9	4 - 8	8	19	19	34	100	50.009 PA7035
Pg 11	5 - 10	8	22	22	37	100	50.011 PA7035
Pg 13,5	6 - 12	9	24	24	39	100	50.013 PA7035
Pg 16	10 - 14	10	27	27	42,5	50	50.016 PA7035
Pg 21	13 - 18	11	33	33	47,5	50	50.021 PA7035
Pg 29	18 - 25	11	42	42	53	25	50.029 PA7035
Pg 36	22 - 32	13	53	53	61	10	50.036 PA7035
Pg 42	30 - 38	13	60	60	65	5	50.042 PA7035
Pg 48	34 - 44	14	65	65	67	5	50.048 PA7035

## Connecting thread long

A	ØC	L	SW1	SW2	H		Part No.
Pg 7	3 - 6,5	15	15	15	37,5	100	50007/7035/15
Pg 9	4 - 8	15	19	19	41	100	50009/7035/15
Pg 11	5 - 10	15	22	22	44	100	50011/7035/15
Pg 13,5	6 - 12	15	24	24	45	100	50013/7035/15
Pg 16	10 - 14	15	27	27	47,5	50	50016/7035/15
Pg 21	13 - 18	15	33	33	51,5	50	s50021/7035/15
Pg 29	18 - 25	15	42	42	57	25	50029/7035/15

A	ØC	L	SW1	SW2	H		Part No.
---	----	---	-----	-----	---	--	----------

Pg 36	22 - 32	18	53	53	66	10	50036/7035/18
-------	---------	----	----	----	----	----	---------------



RAL 7001

## Connecting thread standard length

A	ØC	L	SW1	SW2	H		Part No.
---	----	---	-----	-----	---	--	----------

Pg 7	3 - 6,5	8	15	15	30,5	100	50.007 PA
Pg 9	4 - 8	8	19	19	34	100	50.009 PA
Pg 11	5 - 10	8	22	22	37	100	50.011 PA
Pg 13,5	6 - 12	9	24	24	39	100	50.013 PA
Pg 16	10 - 14	10	27	27	42,5	50	50.016 PA
Pg 21	13 - 18	11	33	33	47,5	50	50.021 PA
Pg 29	18 - 25	11	42	42	53	25	50.029 PA
Pg 36	22 - 32	13	53	53	61	10	50.036 PA
Pg 42	30 - 38	13	60	60	65	5	50.042 PA
Pg 48	34 - 44	14	65	65	67	5	50.048 PA

## Connecting thread long

A	ØC	L	SW1	SW2	H		Part No.
---	----	---	-----	-----	---	--	----------

Pg 7	3 - 6,5	15	15	15	37,5	100	50.007 PA15
Pg 9	4 - 8	15	19	19	41	100	50.009 PA15
Pg 11	5 - 10	15	22	22	44	100	50.011 PA15
Pg 13,5	6 - 12	15	24	24	45	100	50.013 PA15
Pg 16	10 - 14	15	27	27	47,5	50	50.016 PA15
Pg 21	13 - 18	15	33	33	51,5	50	50.021 PA15
Pg 29	18 - 25	15	42	42	57	25	50.029 PA15
Pg 36	22 - 32	18	53	53	66	10	50.036 PA18