



componenti per elettrodomestici



# ONE WAY INLET VALVE

# ES 90/88

TIPO ES 90/88

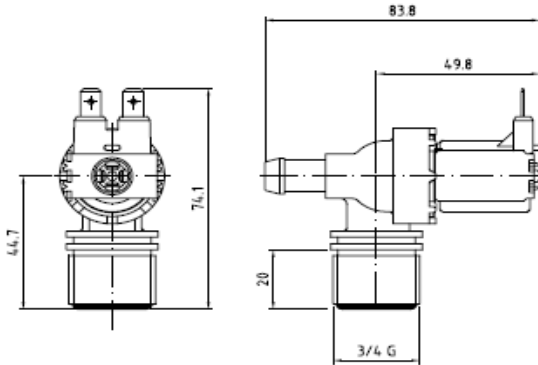

## Coils

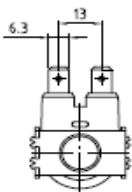

- 220/240V 50-60Hz 8VA
- 220/240V 50-60Hz 8VA RINF.
- 12V 50-60Hz
- 12V DC
- 24V 50-60Hz
- 24V DC

0.2-10 bar (0.02-1Mpa)  
T60°C Tm25°C 100% ED  
T60°C Tm90°C AB 3/5MIN.

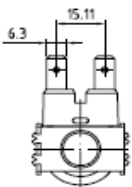

120V 60Hz

0.2-10 bar (0.02-1Mpa)  
T60°C Tm25°C 100% ED  
T60°C Tm90°C AB 3/5MIN.

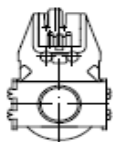

- 220/240V 50-60Hz 8VA
- 220/240V 50-60Hz 8VA RINF.
- 120V 60Hz
- 24V DC

0.2-10 bar (0.02-1Mpa)  
T60°C Tm25°C 100% ED  
T60°C Tm90°C AB 3/5MIN.

## Inlet thread

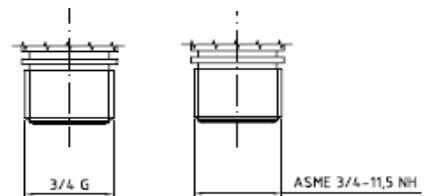

## Outlet

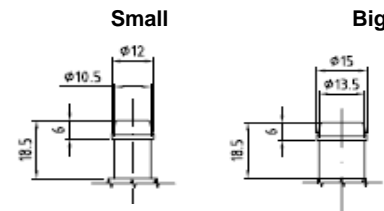

## Bracket

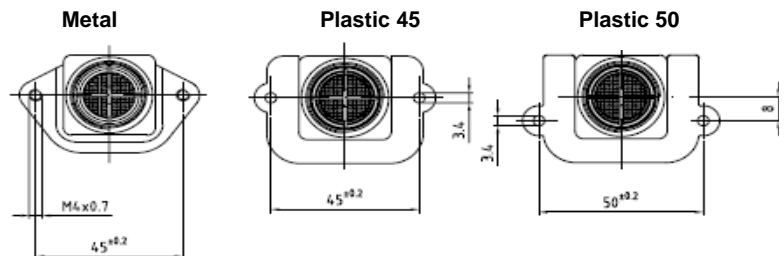

## Flow Regulators

### INLET REGULATORS

l/min	Colour	l/min	Colour
2,5	brilliant yellow	7	light green
3	red	8	black
3,5	light blue	10	white
3,8	pink	11	orange
4	dark brown	12	blue
4,5	blue	14	green
5	violet	16	light brown
5,5	yellow	20	brilliant red
6	gray		

### OUTLET REGULATORS

l/min	Colour	l/min	Colour
0,25	red	1.5	light brown
0,35	violet	2.5	yellow
0.5	orange	3	dark green
0,8	white	5	black
1	light blue	8	blue
1.2	dark brown		