

new

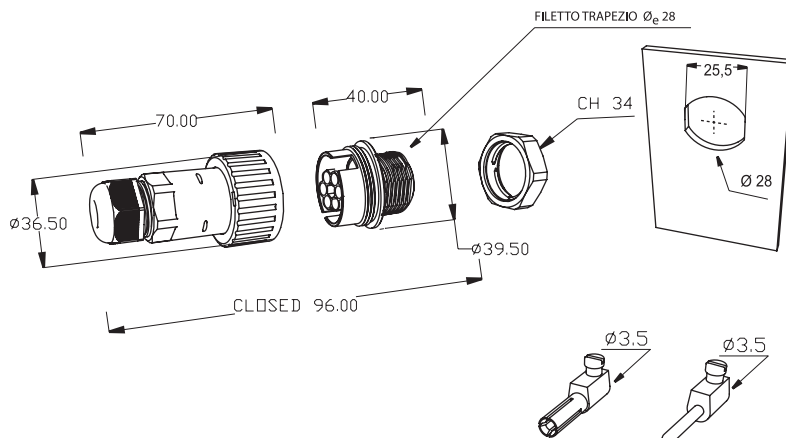

CE RoHS IP68

Dimensioni in millimetri. *Dimensions shown in millimetres.*

Dati generali *General data*

Dati tecnici *Technical data*

N. poli	2	3	5	6	N. poles
Terminali	vite/perforazione/pin screw/piercing/crimp				Terminals
Sezione cavo	max 4.0 mm ² (bussola a vite screw terminals) 0.5 mm ² - 1.5 mm ² (bussola a perforazione piercing clip terminals)				Cable section
Diametro cavo min-max ⁽¹⁾	7.0 mm - 14.0 mm				Cable diameter min-max ⁽¹⁾
Grado di protezione (IP)	IP68 0.5 bar (5 m / 1 h)				Degree of protection (IP)
Corrente e tensione nominale	24A 400V (10A crimp) 16A 400V (10A crimp)				Rated current and voltage
T marking	T125°C				T marking
Temperatura di funzionamento	-40°C to +125°C				Operating temperature
Categoria di sovratensione	II				Impulse withstand category
Tensione di tenuta ad impulso	4 kV		6 kV		Impulse withstand voltage
Grado di inquinamento	2				Pollution degree
Indice di tracking	PTI 175				Tracking index

Materie prime *Raw materials*

Corpo plastico	PA66 UL94 V0/V2 GWT 850°C nero <i>black</i> - grigio <i>grey</i> RAL7035	Connector housing
Corpo plastico morsettiera e dadi	PA66 GF UL94 V0 GWT 960°C ⁽¹⁾ nero <i>black</i> - grigio <i>grey</i> RAL7035	Terminal block housing and lock nuts
Gommini di tenuta cavo e guarnizioni	TPE/silicon	Grommets and seals
Ghiera di chiusura	ottone nichelato <i>brass nickel plated</i>	Ring closure
Bussole	ottone nichelato <i>brass nickel plated</i> ottone argentato <i>brass silver plated</i> (.AG)	Contact screw terminals
Viti standard	M3 acciaio zincato passivato <i>steel zinc plated</i>	Screws
Viti perforazione	M3 acciaio zincato ottonato <i>steel zinc brass plated</i>	Piercing screws

Norme *Standards*

EN61984:2001

Note: (1) Per cavi $\varnothing \leq 7.0$ mm si consiglia l'utilizzo dell'accessorio codice 6000087LF. *For cable $\varnothing \leq 7.0$ mm it is recommended to use the accessory code 6000087LF.*





























TH409 PATENTED

CONNETTORE PRESA-SPINA AD ALTA PROTEZIONE IP68 DA PARETE. 2-3-5-6 POLI.
IP68 PROTECTION PANEL MOUNTED PLUG AND SOCKET CONNECTOR. 2-3-5-6 POLES.

TH409





















Codice Order number







Bussole Inserts (17.5A - 25A)

versione version	n. poli n. poles	bussola contact terminal	pz/imb pcs/box	codice order number
 PLUG	2		200	THB.409.A1G
 POWER SOCKET 			200	THB.408.B2G
 PLUG	3		200	THB.409.A1B
 POWER SOCKET 			200	THB.408.B2B
 PLUG	5		200	THB.409.A1A
 POWER SOCKET 			200	THB.408.B2A
 PLUG	6		200	THB.409.A1E
 POWER SOCKET 			200	THB.408.B2E
Le versioni sopra indicate sono disponibili con terminali a perforazione di isolante (17.5A). The above versions are available with piercing clip terminal blocks (17.5A).			200	THP.409.AXX
			200	THP.408.BXX
Note:	  Bussole con vite. Per sezioni cavo < 1.0 mm ² si consiglia l'utilizzo del puntalino. Contact screw terminals. For cable section < 1.0 mm ² we suggest to use a cable tip.	  Bussola a perforazione max 1.5 mm ² . Piercing clip terminal max 1.5 mm ² .	  Per pin cilindrici universali Ø 2 mm (non forniti). For universal cylindrical pin Ø 2 mm (not supplied).	

Codice Order number

Pin Crimp (10A)

versione version	n. poli n. poles	pin crimp	pz/imb pcs/box	codice order number
 PLUG	2		200	THF.409. A1G
 POWER SOCKET 			200	THF.408. B2G
 PLUG	3		200	THF.409. A1B
 POWER SOCKET 			200	THF.408. B2B
 PLUG	5		200	THF.409. A1A
 POWER SOCKET 			200	THF.408. B2A
 PLUG	6		200	THF.409. A1E
 POWER SOCKET 			200	THF.408. B2E

Note:   Bussole con vite. Per sezioni cavo < 1.0 mm² si consiglia l'utilizzo del puntalino. *Contact screw terminals. For cable section < 1.0 mm² we suggest to use a cable tip.*
  Bussola a perforazione max 1.5 mm². *Piercing clip terminal max 1.5 mm².*
  Per pin cilindrici universali Ø 2 mm (non forniti). *For universal cylindric pin Ø 2 mm (not supplied).*

TH409 PATENTED

CONNETTORE PRESA-SPINA AD ALTA PROTEZIONE IP68 DA PARETE. 2-3-5-6 POLI.
IP68 PROTECTION PANEL MOUNTED PLUG AND SOCKET CONNECTOR. 2-3-5-6 POLES.

TH409

Varianti Options





Bussole Contact Terminals

versione version	codice order number
bussole in ottone argentato <i>brass silver plated contact screw terminals</i>	THX.409.XXX.AG

Colore Colour Contatta il Servizio Clienti per maggiori informazioni. *Contact our Customer Service for availability.*

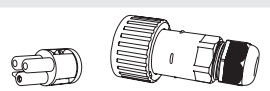
versione version	codice order number
<input checked="" type="checkbox"/> grigio grey RAL 7035	THX.409.XXX.CG THX.408.XXX.CG
<input type="checkbox"/> altri colori <i>other colours</i>	THX.409.XXX.CX THX.408.XXX.CX

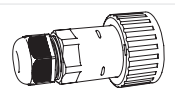
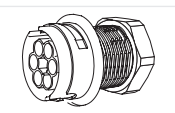
Kit di fornitura Purchasing kit

versione version	misure imballaggio box dimensions	contenuto contents	pz/imb pcs/box	codice order number
kit non assemblato <i>unassembled kit</i>	C05 (395x395x185 mm)		200	THX.408.XXX
				THX.409.XXX
kit assemblato <i>assembled kit</i>	C05 (395x395x185 mm)		200	THX.408.XXX.Z
				THX.409.XXX.Z
kit imbustato <i>retail pack kit</i> Consulta il catalogo Rivenditori. <i>See the Retailers catalogue.</i>	--		--	THX.409.XXX.R
versione speciale <i>custom version</i>	*	*	*	THX.409.XXX.K

Note: Per maggiori informazioni sugli accessori consulta pagina 252. Per maggiori informazioni sulle istruzioni di assemblaggio consulta www.techno.it.
For more information about accessories see page 252. For more information about assembling instructions see www.techno.it.

Entrambe le custodie dei connettori possono ricevere indistintamente il frutto maschio o femmina. Per ragioni di sicurezza, solo il frutto femmina deve essere utilizzato per portare tensione.
Every connector housing type can be equipped with male or female contacts. For reasons pertaining to safety, only female contacts may be used in the live part of the connector.

* Sono possibili personalizzazioni di prodotto e progetti su richieste specifiche. Contatta il Servizio Clienti.
Personalization and new custom products are possible. Please contact our Customer Service.

Eventuali modifiche e migliorie sui dati tecnici o sul prodotto potranno essere effettuate senza preavviso.
All technical data or other eventual product modifications and improvements can be carried out without notice.